

NOTES:

- ① JUNCTION BOXES: J1--NORMAL POWER, J2--EMER. POWER, J3--NURSE CALL/TELEPHONE.
- ② GAS PIPING: TYPE L COPPERTUBING. OXYGEN & AIR--1/2" I.D., VACUUM--3/4" I.D.
- ③ COLOR TO MATCH 'SURF' OR 'PLATINUM GREY'.
- ④ CEILING HEIGHT: 7'6" MIN TO 9'6" MAX. OTHER HEIGHTS ARE SUBJECT TO AN ADDTL CHARGE. CONTACT YOUR SALES REPRESENTATIVE FOR DETAILS.
- ⑤ MAXIMUM CONDUIT SIZE FOR DOUBLE-SIDED UNITS IS 3/4".

MODULAR SERVICES COMPANY 500 EAST BRITTON ROAD
OKLAHOMA CITY, OK. 73114

REVISED

PROFILE® UNIT
SINGLE SIDED, SEMI-RECESSED
MODEL 7011

PROJECT

SCALE:  = 1'

DATE _____ DRAWN BY _____ DRAWING #
PB-155

SERVICES TO BE REVERSED
ON OPPOSITE HAND UNITS

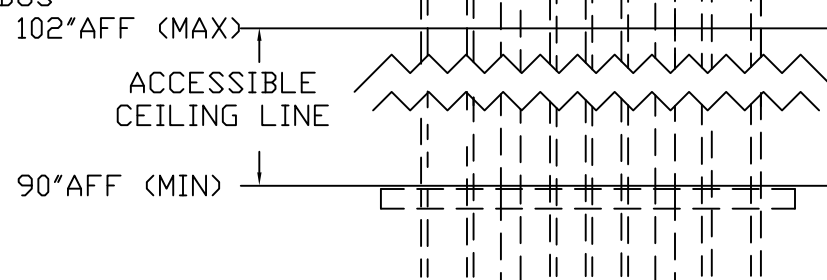
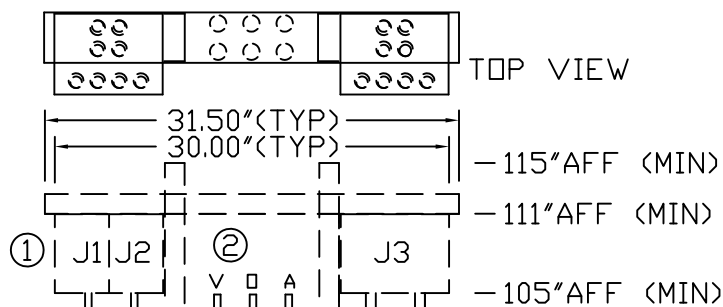
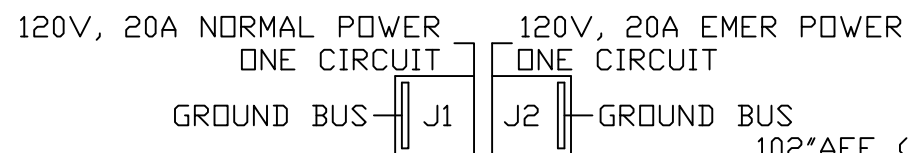

LOW ACUITY
-- REQ'D: -- AS SHOWN
-- OPPOSITE

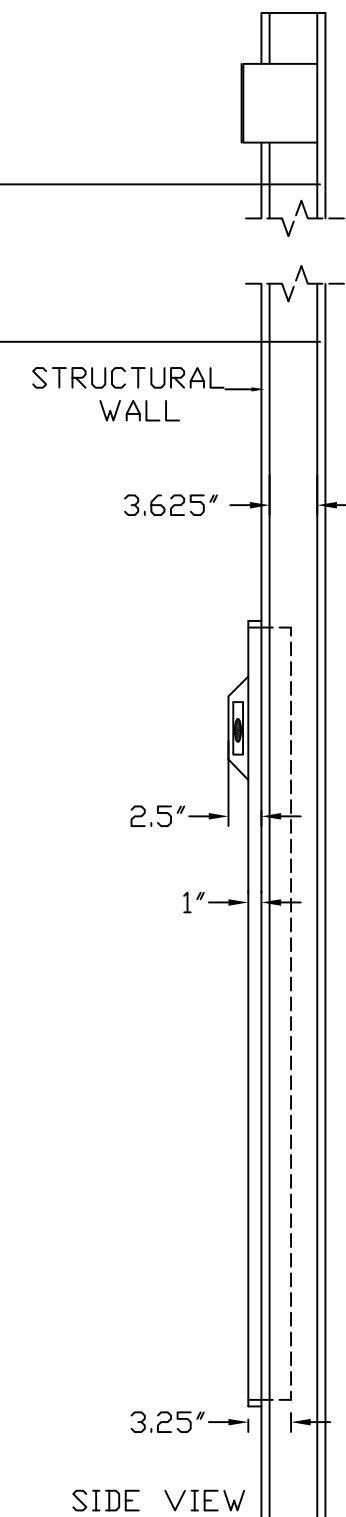
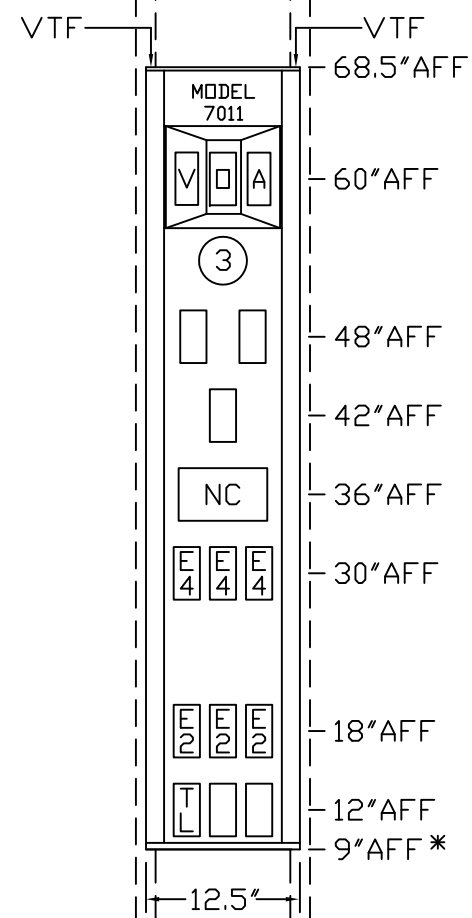
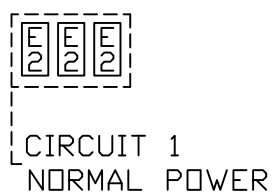
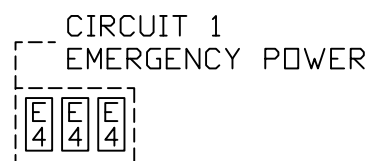

WIRING DIAGRAM
GROUND WIRING TO BE #10
GREEN STRANDED COPPER

FLOOR LINE

*AFF (ABOVE FINISHED FLOOR)

