

**NOTES:**

- ① JUNCTION BOXES: J1--NORMAL POWER, J2--EMERGENCY POWER, J3--NURSE CALL/TELEPHONE.
- ② GAS PIPING: TYPE L COPPER TUBING. OXYGEN & AIR-- $\frac{1}{2}$ " I.D., VACUUM-- $\frac{3}{4}$ " I.D.
- ③ ALL POWDER COATED SURFACES WILL MATCH 'SURF' OR 'PLATINUM GREY'.
- ④ ALL INTERIOR STUD FRAMING IS TO FIT A  $3\frac{5}{8}$ " METAL STUD WALL WITH A  $\frac{5}{8}$ " GYPSUM BOARD FINISH.
- ⑤ EMT CONDUIT: C1--MONITOR OUTPUT ( $1\frac{1}{4}$ ").
- ⑥ CEILING HEIGHT 7'6" MIN TO 9'6" MAX OTHER HEIGHTS ARE SUBJECT TO AN ADDITIONAL CHARGE. CONTACT YOUR SALES REPRESENTATIVE FOR DETAILS.

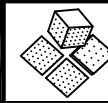

**MODULAR SERVICES COMPANY** 500 EAST BRITTON ROAD  
OKLAHOMA CITY, OK. 73114

PROJECT

REVISED

EXTENDED PROFILE® UNIT  
SINGLE SIDED, SEMI-RECESSED  
MODEL 7111A-Q

SCALE: =1'

DATE \_\_\_\_\_ DRAWN BY \_\_\_\_\_ DRAWING #  
PB-179

LOW ACUITY

-- REQ'D: -- AS SHOWN  
-- OPPOSITE

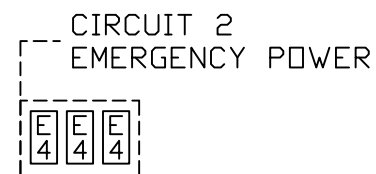
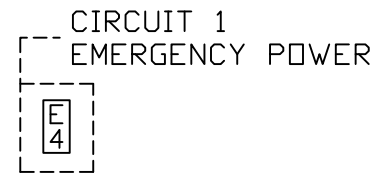
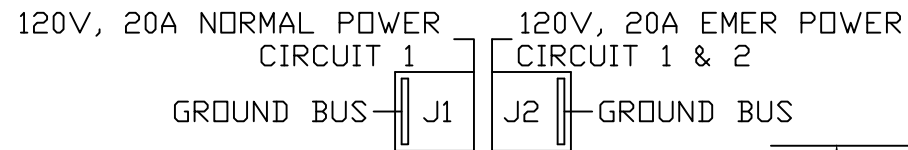

WIRING DIAGRAM  
GROUND WIRING TO BE #10  
GREEN STRANDED COPPER

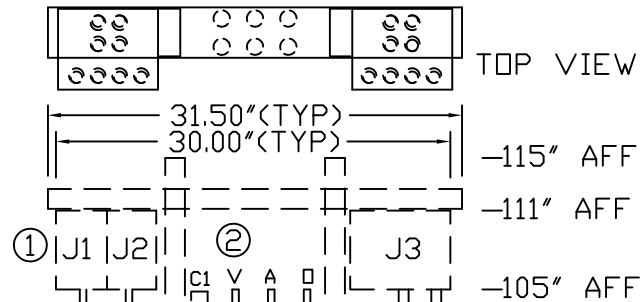

SERVICES TO BE REVERSED  
ON OPPOSITE HAND UNITS

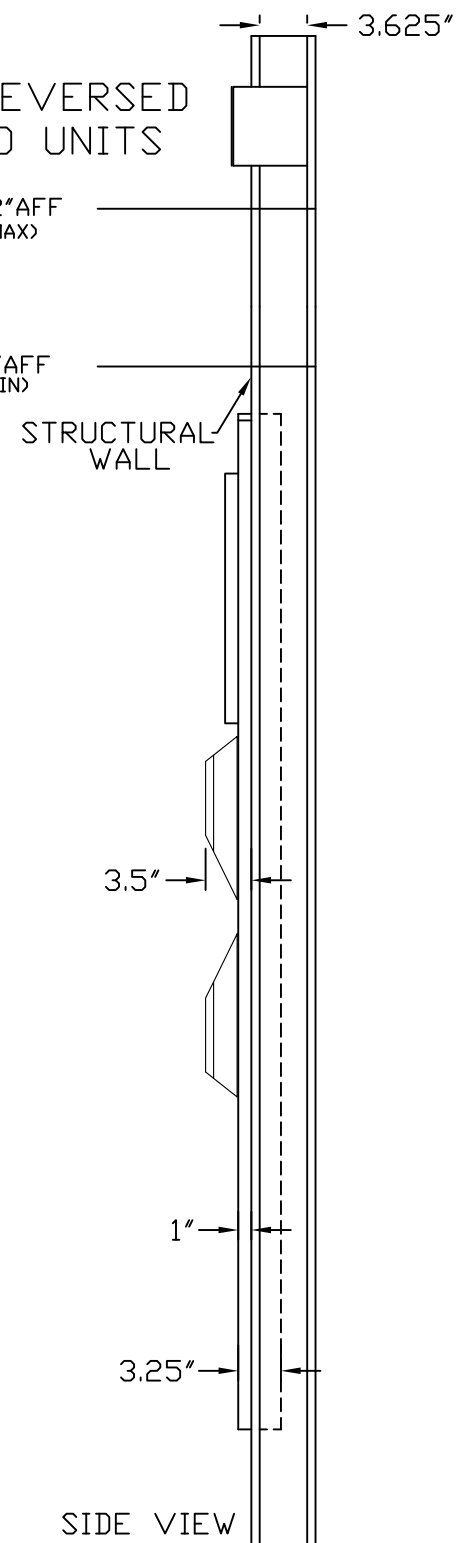
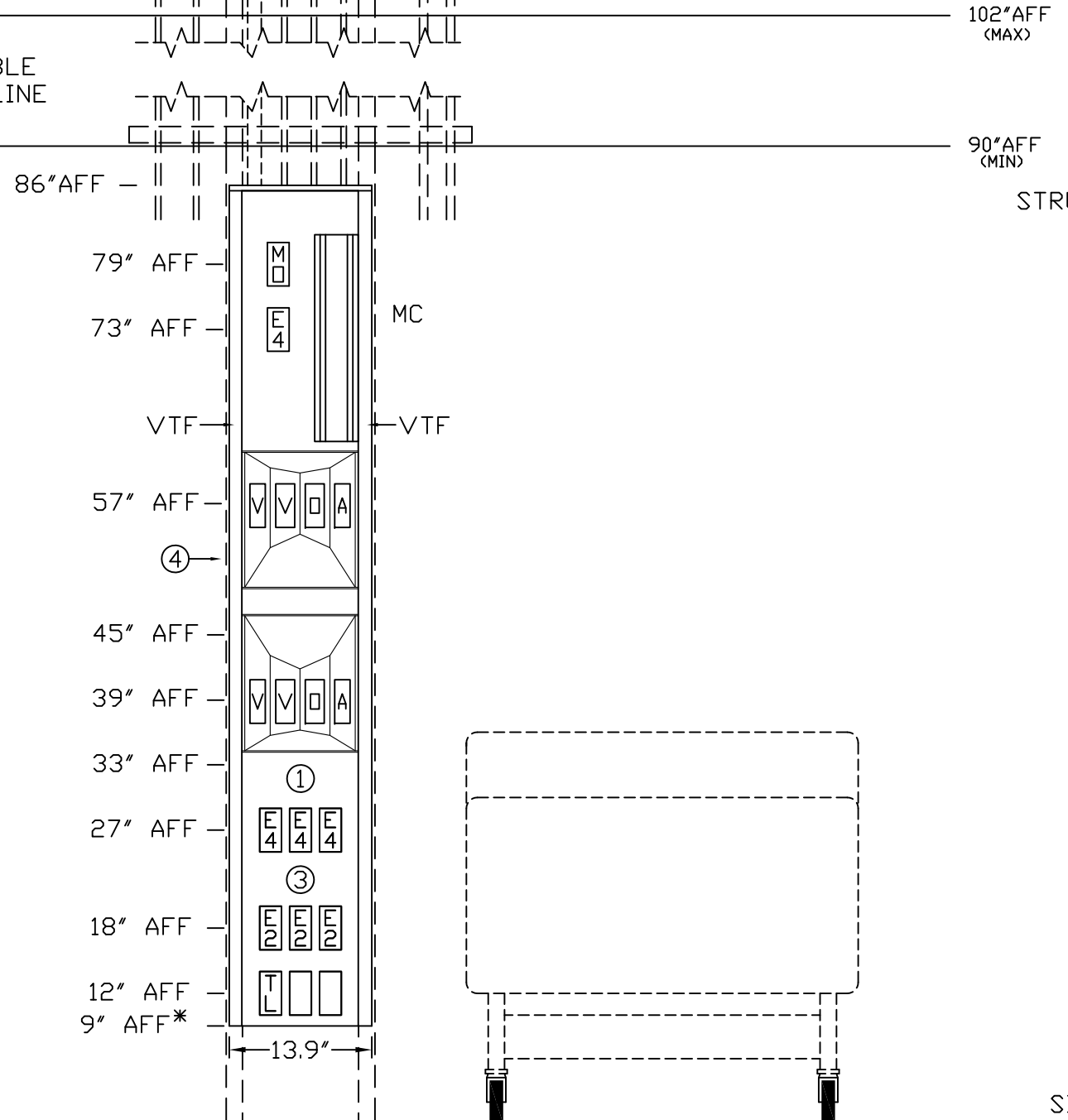

SIDE VIEW

FLOOR LINE

\*AFF (ABOVE FINISHED FLOOR)

